

magnetic Demineralization

basic mobil plus/pro

Instructions for use



basic mobil plus

basic mobil pro

magnetic ...einfach besser

magnetic GmbH & Co. KG
Am Richtbach 5
D-74547 Untermünkheim

Tel. +49 7944 94199-0
Fax +49 7944 94199-19

info@magnetic-online.de
www.magnetic-online.de

CEO:
Michael Bader

VAT ID No: DE 255 018 730
Trade Register: HRA 571362
Registered court: Stuttgart

Version: BMP_ENG_10.2021

magnetic Demineralization

basic mobil plus/pro

Content

The function	4
Connection type for system filling.....	5
Connection type for circulation demineralization	6
Operating the measuring computer	7
Replacing the mixed bed resin	8
Calculating the capacity	9
Technical data	10
Troubleshooting	11

magnetic ...einfach besser

The function

Heating and cooling systems use water as a medium for heat transfer. The water circulates from the place of heat production to the consumer units and back again. Even though the system always reuses the same water, limescale (calcium carbonate) and other aggressive substances that can damage modern components already get into the closed water system during the first filling.

The filling station removes limescale (calcium carbonate) and aggressive water constituents, like sulphates, nitrates and chlorides, from the filling water. The device works on the basis of a mixed-bed-resin ion exchanger and delivers a water in fully demineralised quality. That allows damage by limescale and corrosion in the heating system to be effectively prevented.

The filling station is equipped with precise measuring devices for the monitoring of the quality and quantity of the pure water production.

This method does not add any chemical additives to the water.

The device works without an external power supply.

Precautionary measures:

Work with the filling station may only be performed by trained personnel.

The operating rules in accordance with these instructions must be observed.

The local regulations must be observed for the connection between sanitary systems and heating systems. The device is equipped with a non-return valve and pressure-reducing valve but a pipe isolator (shut-off valve) must also be installed on the inlet side of the filling station if the place of installation is subject to DIN EN 1717 (Germany).

The valves at the inlet and outlet must be kept closed and may only be opened for the duration of the system filling.

Demineralised water also contains dissolved gases, of which oxygen and carbon dioxide can trigger an initial corrosion process. The gases are forced out through the heating of the water and that is why a test heating of the system as quickly as possible after the filling is recommendable.

Connection type for system filling

This connection type is suitable for a direct filling of the heating system with demineralised water.

The inlet for the untreated water is located at the rear right side, the outlet of the demineralised water to the heating system is located at the front behind the measuring computer.

The filling station is equipped with a non-return valve. Untreated water cannot flow through the filling station in the case of an incorrect connection.

Precautionary measures:

A backflow preventer must also be installed on the inlet side of the filling station if the place of installation is subject to DIN EN 1717 (Germany).

Flush out the water content of the station before each use because bacteria can form in the case of a long non-use. When doing that, also check that the water does not accidentally contain mixed bed resin.

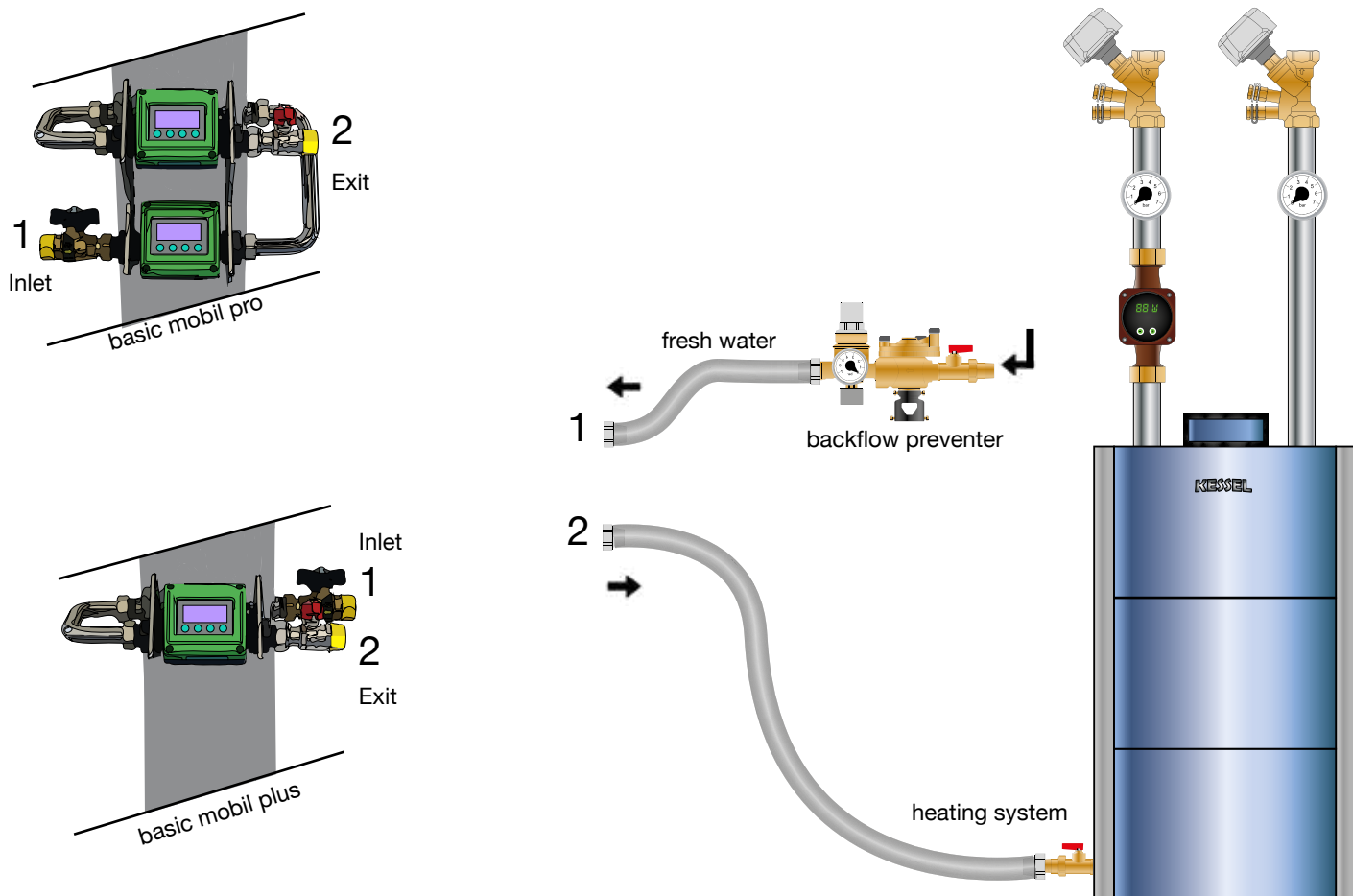

magnetic ...einfach besser

Connection type for circulation demineralization

A direct filling via the demineralisation device is unsuitable for heating systems with floor heating systems that can only be vented through flushing. The pump power is not sufficient for forcing the air out of a horizontal pipe. In such a case, we recommend a filling with untreated water and then a circulation demineralisation.

This method is also suitable for a subsequent demineralisation of system water with a too high mineral content in accordance with the specifications of the boiler manufacturer or directives. For this method, the demineralisation device is integrated into the main circulation of the heating system with the aid of a separate pump (e.g. impeller pump) and 2 armoured hoses. Which coupling fittings are used for the connection is not of utmost importance, more important is that the circulation pumps are in operation and that all valves are open in order to allow a good mixing of the system water.

The combined meter of the filling station shows when the resin is exhausted. The progress of the demineralisation of the system water in the case of a circulation demineralisation can only be determined with a second measuring computer or with a water sample analysis.* The filling station is equipped with a non-return valve.



The temperature in the filling station may only reach a maximum of 60°C for a short time if this type of flushing is done whilst the heating system is in operation. The filling station should be connected to a return flow point with a low temperature.



Only hoses with a sufficient pressure and temperature resistance may be used (armoured hoses). The filling station must not be unsupervised when it is pressurised.

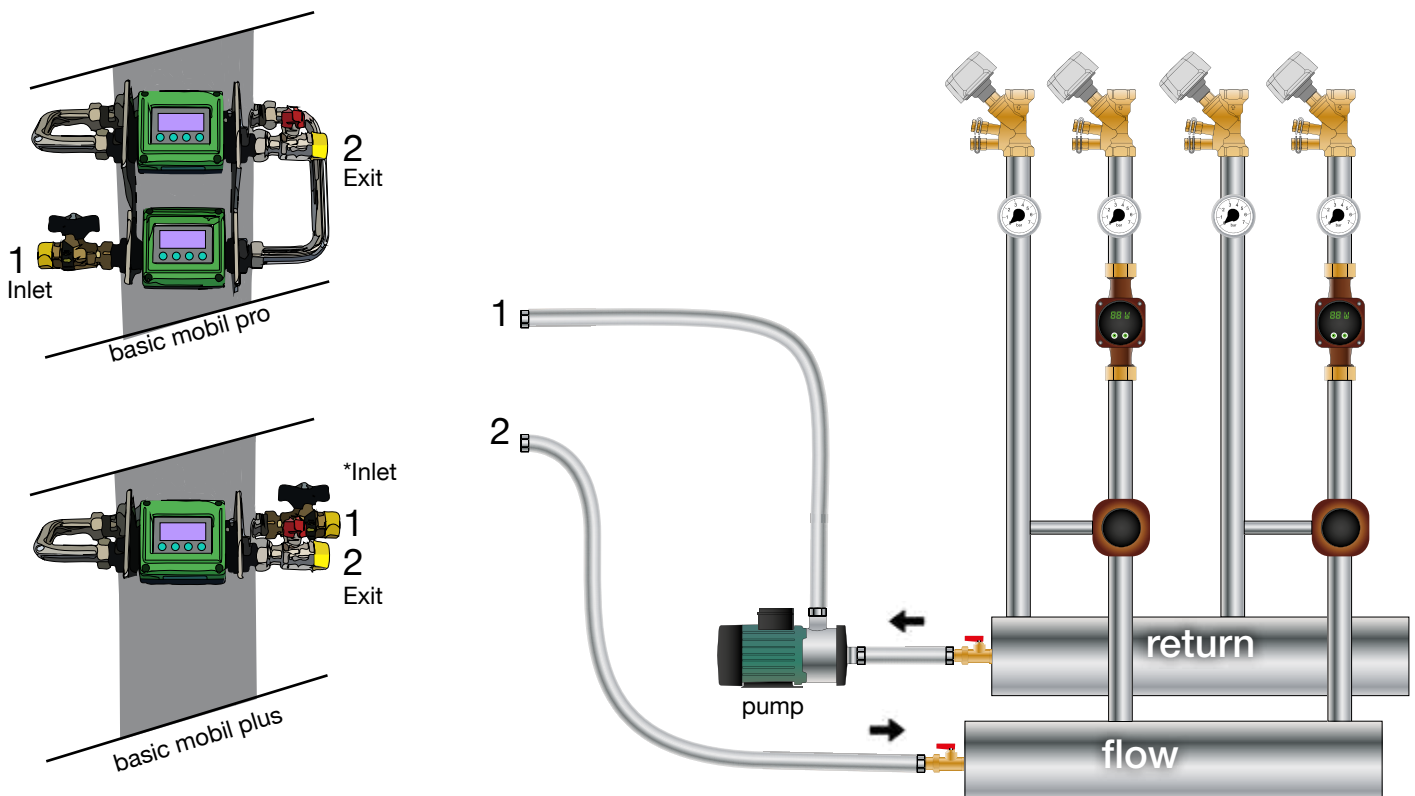

*To check the progress of demineralization of the system water, a second measuring computer must be connected. Preferably at the inlet to the filling station

Operating the measuring computer

The combined meter is battery-powered. It measures the flow rate in l/min, the total flow in litres and the content of dissolved minerals, either in $\mu\text{S}/\text{cm}$ (microsiemens/cm) or TDS. It is also possible to set a limit for the maximum still tolerated mineral content in the demineralised water (outlet of the filling station). The limit value and the total quantity value can be reset.

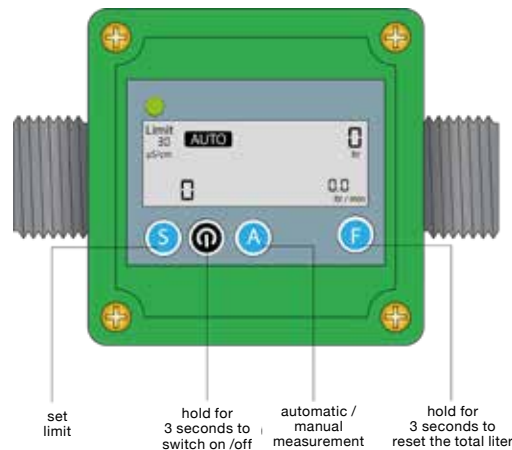

Switching the conductivity value to TDS / Manual measurement of the conductivity

The factory setting of the measuring computer is electrical conductivity displayed in " $\mu\text{S}/\text{cm}$ ". To switch the measurement to TDS in „ppm“, briefly press the power button. The measuring computer now shows „ppm“ (instead of „ $\mu\text{S}/\text{cm}$ “).

Press the “A” key to display the current conductivity value ($\mu\text{S}/\text{cm}$). The maximum settable conductivity value is 1999 $\mu\text{S}/\text{cm}$.

Automatic monitoring of the conductivity / Set limit

Press the “S” key to set the limit value for the conductivity in the display. The increase step is 15 $\mu\text{S}/\text{cm}$. A longer pressing of the “S” key resets the value back to zero.

Switch to automatic mode after you have set a limit value. Do that by pressing the “A” key to first do a manual test. Then press the “A” key again to switch to the automatic mode. “Auto” will then be shown in the display.

The conductivity will then be measured again every 20 litres. The LED on the left above the display blinks green for 30 seconds if the measured value is below the previously set limit value. The LED will start to blink red and an alarm tone will be emitted if the measured value exceeds the set limit value.

Switching between - automatic and manual monitoring / litre and gal

Press the “A” key to switch from automatic to manual mode and thus reset the last measured value of the automatic monitoring.

When keeping the “F” button pressed too long that units switch to gallons. This can only be reversed by newly inserting the batteries and keeping the “A” button pressed.

i *Practical tip: When all basic settings have been made (automatic mode & limit) it is sufficient if the measuring computer is only switched **on** and **off** in practice. All settings are saved.*

magnetic ...einfach besser

Replacing the mixed bed resin

The resin must be replaced when the content of dissolved substances in the treated water, measured by the combined meter, exceeds 30 $\mu\text{S}/\text{cm}$ or 20 TDS.

1. Close all valves, remove safety strainer on the drain tap

2. Connect a hose to the drain tap, with the other hose end in the supplied water permeable collection bag

3. Connect the inlet to a drinking water tap with a hose

4. Open the inlet tap and the drain tap and flush out the resin until clear water comes out - the resin is then completely emptied.

5. Close the inlet tap and open the vent tap on the lid. Air can now get into the device and water in the filling station can flow out of the drain tap.

6. Used mixed bed resin can be disposed of with the normal household waste.

7. Close the drain tap, remove the hose and reinstall the safety strainer.

8. Refill with new resin.

9. Then vent the device again.

10. Put on the lid, connect the hoses and reset the measuring computer.

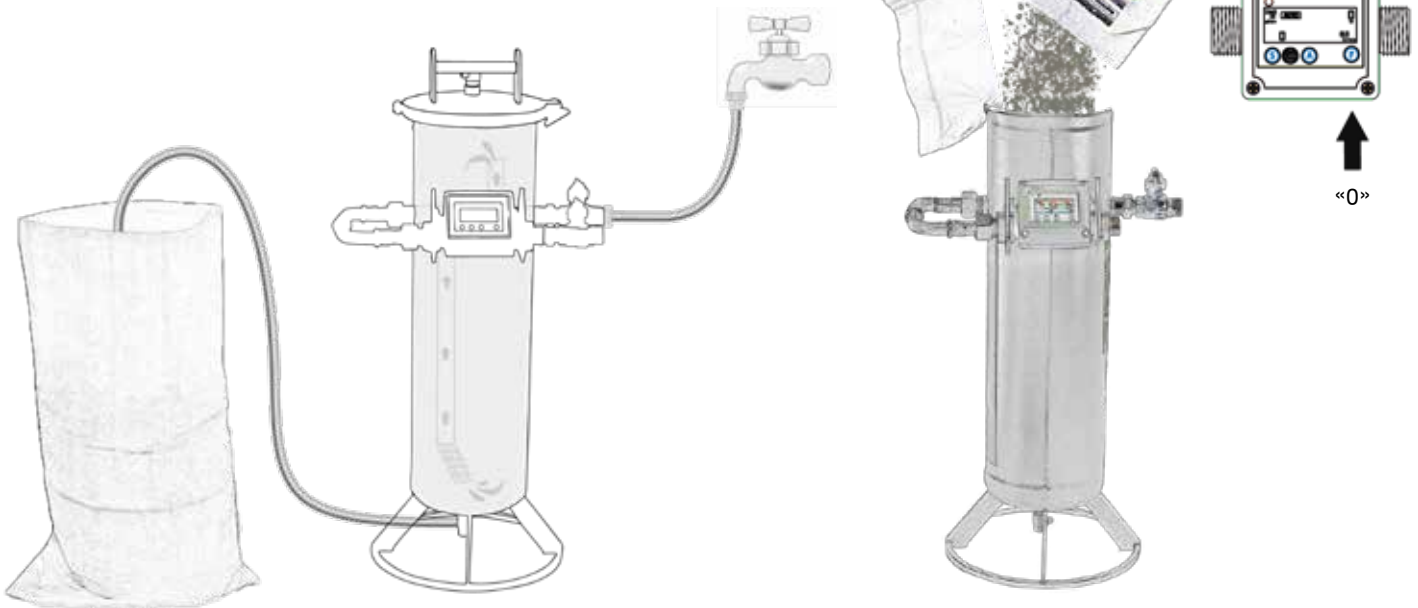

Take care that no resin is spilled onto the floor. Danger of slipping. Spilled resin must be carefully and thoroughly removed.

The resin granulate is supplied in vacuum-sealed plastic bags. Opened bags must be quickly used. The resin can be stored in a cool and dark place. Improper storage can result in a capacity loss and bacteria formation

Capacity of the mixed bed resin

The capacity (range) of the mixed bed resin depends on the water hardness. It can be read from the diagram below or calculated with the capacity number of the amount of resin.

Fillstation	Capacity figure at 1° dH
basic mobil plus/pro	24.000 liter

The capacity figure is used and divided by the raw water hardness in ° dH. The result is the capacity of the mixed bed resin in liters per 12.5 liter mixed bed resin.

 The conversion from $\mu\text{S}/\text{cm}$ to water hardness gives only an approximate value and is only possible for untreated drinking water. Other water types contain not only limescale (calcium carbonate) but also other dissolved minerals. The capacity would then be less because the filling station removes all minerals.

Capacity basic mobil plus/pro

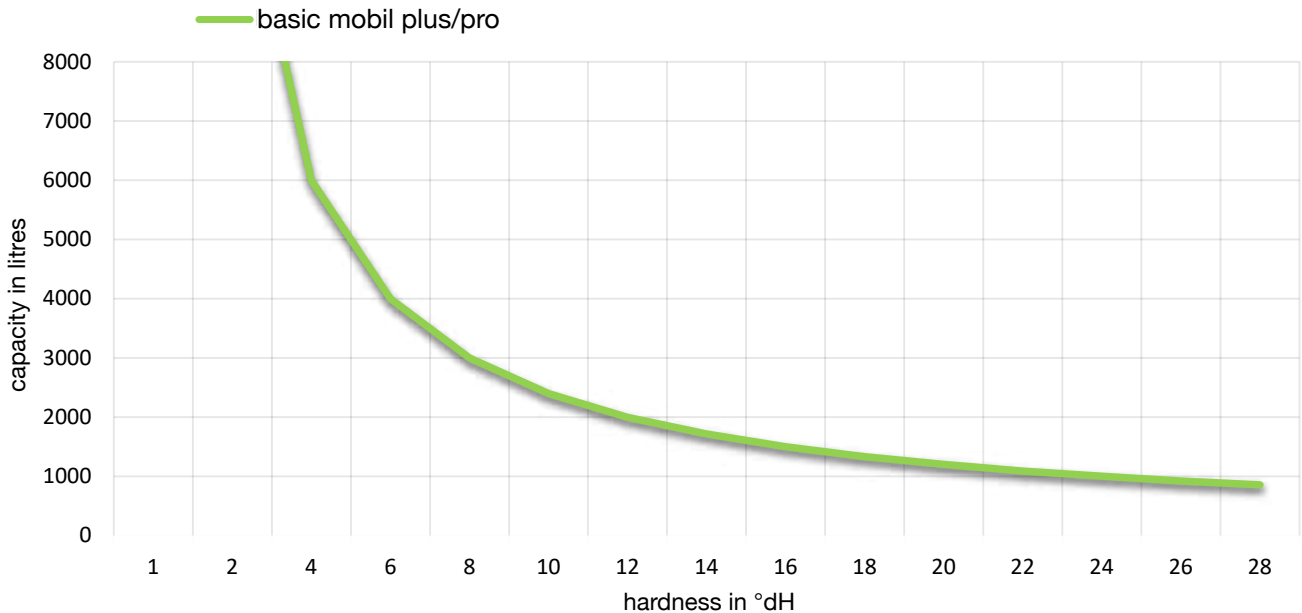

magnetic ...einfach besser

Technical data

Capacity 12,5 Litres filling	24000 litres at 1°dH / 2400 litres at 10°dH
Max. flow rate	1000 litres/h at 3-4 bar supply pressure
Test pressure	6 bar
Screw coupling	DN 20 / 3/4 outer thread
Total height:	1022 mm
Diameter	170 mm
Weight ready-for-use	23 kg

- 1 Carrying handle
- 2 Vent tap
- 3 Quick-action fastener
- 4 Outlet
- 5 Inlet with non-return valve and optimises water feed system
- 6 Measuring computer
- 7 Standing foot
- 8 Drain tap with safety strainer for frost protection
- 9 Safety strainer in inlet to measuring computer

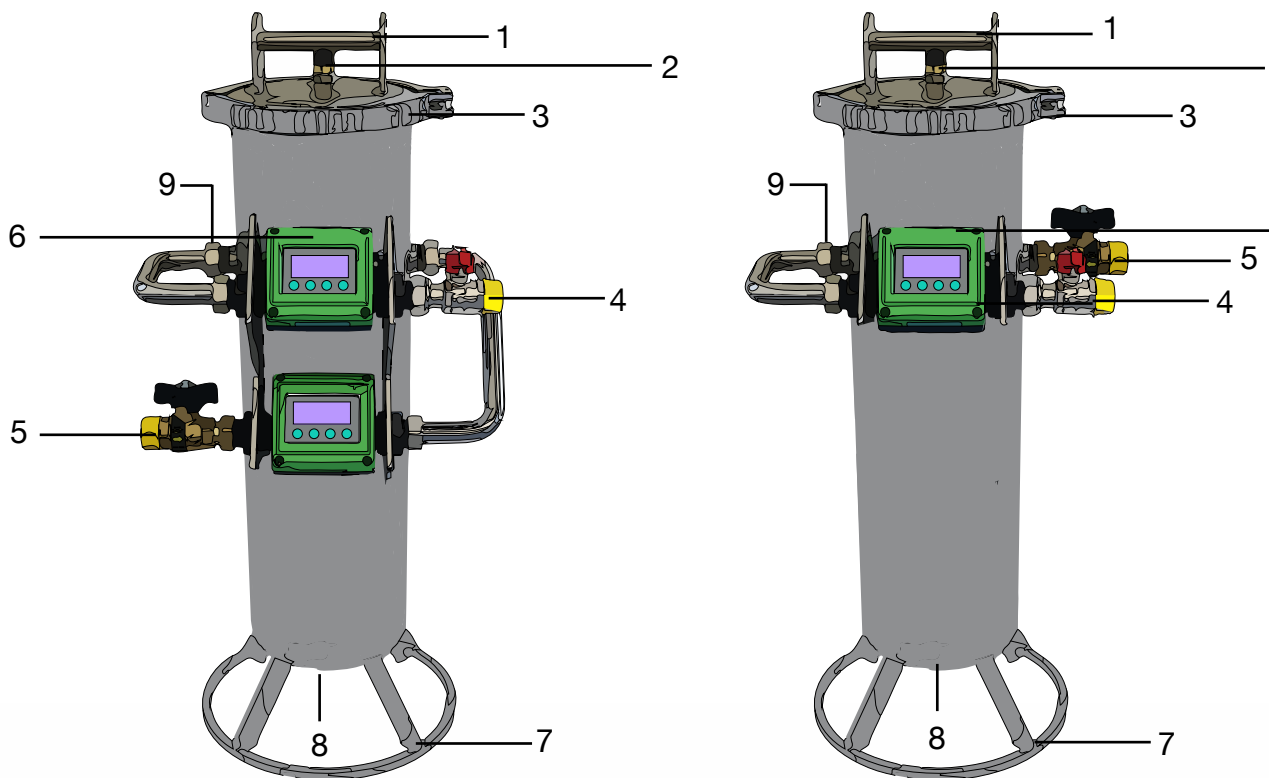

Fault

No display or battery symbols appears

The resin is exhausted quicker than calculated

The flow is weak despite fully open supply line

Solution

Low battery power alert

The “battery” symbol on the display will blink when the batteries are drained. The last measured and displayed value and the settings will be stored and recovered when the battery replacement is completed.

Inserting/replacing the batteries

Remove the four front screws of the housing (see illustration below) and insert three batteries (AAA alkaline) into the battery holder. The front part of the housing can be turned by 90° or 180° if desired before fastening with the screws.



Loss of capacity

There is probably no fault. It could be that the untreated water contains not only limescale (calcium carbonate) but also other dissolved substances (sulphates, nitrates, chlorides) which are removed and thus reduce the capacity.

No or weak flow

The filling station has one safety strainers to prevent the mixed bed resin from getting into the heating system. Regularly clean the safety strainer at the outlet.

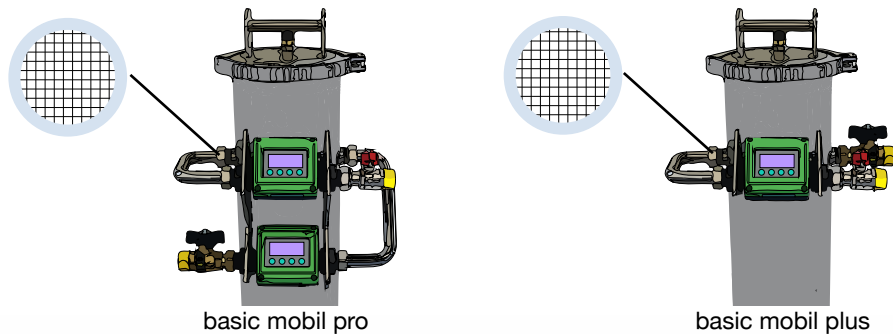

magnetic ...einfach besser

magnetic GmbH & Co. KG
Am Richtbach 5
D-74547 Untermünkheim

Tel. +49 7944 94199-0
Fax +49 7944 94199-19

info@magnetic-online.de
www.magnetic-online.de

CEO:
Michael Bader

VAT ID No: DE 255 018 730
Trade Register: HRA 571362
Registered court: Stuttgart

www.magnetic-online.de